

The behr range
for Extraction/ Distillation



www.behr-labor.com

Quality made in Germany 

Contents



The behr range for the extraction

Extraction process	4
Examples	6
Introduction from sample preparation to extraction	7
Assembly of separate components	8
Soxhlet extraction	10
Complete single extraction units	11
Series extraction devices	13
Accessories for Soxhlet extractions	17
Hot extraction according to Twisselmann	22
Complete single extraction units	22
Series extraction devices and accessories	23
Hot extraction according to Randall	24
semi-automatic equipment and accessories	26
Hydrolysis	28
State-of-the-art equipment and accessories	28
Hydrolysis unit and filtration unit	30

The behr range for the distillation

Determining of the alcohol and volatile acid content	32
Determining of the essential oil content	33
Determining of the water content	33
Reflux distillation	34
Saponification value	35
Determining of Vitamin A and E/ of sulfite	36
Determining hydroxyproline content	37
Recirculating condenser	38
Cooling water monitor	39



The behr range for the extraction process



Extraction processes (more precisely: solid-liquid extraction process) are used to separate soluble components from a solid sample.

Examples:

- Determining the fat content in foods
- Determining an impurity (e.g. PCB, abandoned armaments) in soil samples
- Examining the components of natural substances.

Even brewing coffee is an extraction process. However, in the laboratory the focus is on completely dissolving the examined components from the sample under defined conditions and in a not unnecessarily diluted form. In the laboratory, solvents such as ligroin or hexane are used as extraction agents.

The objective of all extraction processes is to dissolve as much of the soluble components as possible with a specific amount of solvent. This is achieved by constantly vaporising the solvent and allowing it to drip into the sample from a reflux condenser. In contrast to a coffee machine, the same solvent is constantly sent back to the sample. The extracted component accumulates in the distillation flask.

Classic extraction: Soxhlet

The standard extraction method is the Soxhlet method. behr apparatus for Soxhlet extractions fulfil all the various requirements in everyday laboratory practice.

- Practical brackets for condensers and intermediate extraction pieces for safe storage between extractions
- Extractor sizes from 30 ml to 5000 ml
- Compact apparatus with one sample position
- Series extraction devices with 4, 6 or 8 sample positions
- Extractors with specially developed siphon tubes (make: "Bröckerhoff") guarantee consistent results across all sample positions.
- Extractors with taps remove the need for additional distillation after the extraction
- Condensers with screw connections improve work safety
- The hydrolysis units (1, 4 or 6 sample positions) also enable acid digestion prior to extraction (determination of the total fat content according to Weibull and Stoldt).

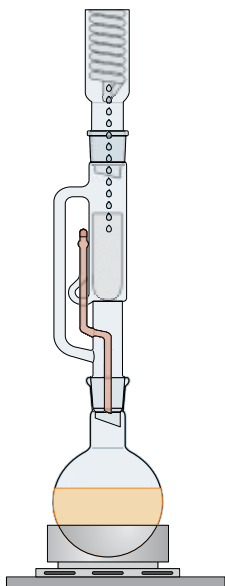

Soxhlet

Hot extraction according to Twisselmann

In the Twisselmann process, the vessel in which the extraction thimble is placed is open at the bottom; the extract immediately flows back into the distillation flask. The extraction thimble is constantly rinsed by the solvent from above and hot steam circulates from below.

Hot extraction according to Randall

The hot extraction process according to Randall consists of three steps:

- Boiling
- Rinsing
- and evaporation.

Boiling

In the first step, the extraction thimble with the sample is located in the vessel with the boiling extraction agent - similar to a tea bag in a cup of hot water. Most of the substance to be extracted should dissolve in this step and is distributed in the solvent. The top part of the apparatus simply acts as a reflux condenser; the condensate drips into the extraction thimble and helps to dissolve the substance.

Rinsing

In the second step, the extraction thimble is lifted out of the pool. Extract may still adhere to the thimble; and some of the substance that has not yet dissolved may still be located in the sample. The condensate from the condenser flushes the remaining extract and progressively dissolves the previously undissolved portion. If the dissolved extract is to be subjected to further processing, the extraction is now complete. Otherwise, the solvent is removed in the third step.

Evaporation

Connect the recirculating tap to the condenser for evaporation. The condensate collects in the lower part of the condenser; it can be reused for the next extraction. Thanks to the short path to the apparatus, the sample can be evaporated until it is almost dry. Benefits of the hot extraction process include

- A compact apparatus with short process paths,
- Low solvent requirement,
- Short extraction period - typically about an hour.

Due to the short extraction period, hot extraction is also gentle on the extract. There are now also an increasing number of analysis processes that use hot extraction.

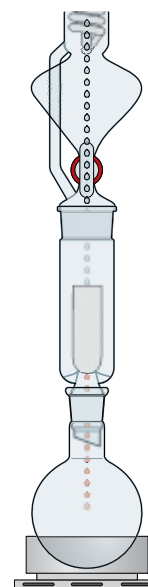

Twisselmann

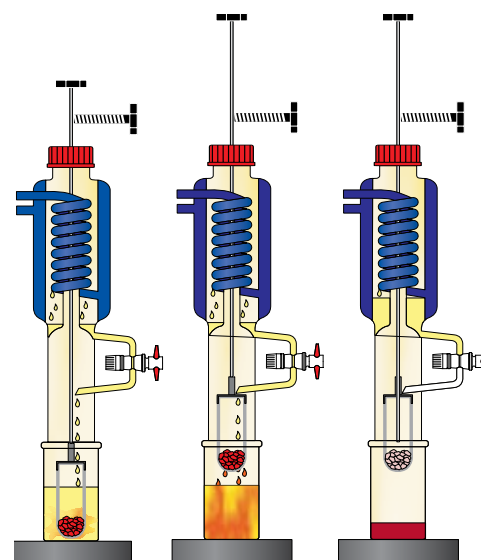

Randall

The “right” extraction for your task - examples



Are you looking to analyse encased and bound fat in food?

- Hydrolysis
- Then use the standard Soxhlet extraction, e.g. fat determination according to Weibull-Stoldt or the AOAC international hydrolysis method



Are you looking to determine the raw fat content in food and processed animal feed (with homogeneous composition)?

- Direct hot extraction according to Randall
- Hydrolysis to determine the total fat content for some samples prior to extraction if required



Are you looking to examine the composition of packaging material or consumer products?
For example

- Hot extraction according to Randall to determine plasticisers in packaging
- Soxhlet extraction of organic compounds from plant tissue



Are you looking to analyse pesticide residues in grain products?

- Extraction of the residues and contaminants from food and fodder samples or other organic materials under inert conditions. The necessary detection limits are reached by higher sample weights

Introduction

from sample preparation to extraction

Only necessary on high fat content and bound fat

Hydrolysis principle

This acid digestion process dissolves both "free fats" as well as "bound fats" from the overall fat content.

The fat is frequently naturally enclosed in the cell matrix of the food or fodder or chemically bound. In these cases, a hydrolysis step before extraction completely releases the fat. Ermittlung des Gesamtfettgehalts nach Weibull und Stoldt.

The user filters the hydrolysate of the separated sample by using a glass sample tube filled with sand or Celite.

The user then rinses the fatty filter residue with water in order to remove the acid.



EXR 4



FU 4

Sample preparation

After drying, the filter residue is finally extracted.
This is done by applying one of the 3 following methods:

Classic extraction:
Soxhlet



R 108 S

Hot extraction
according to Twisselmann



R 106 T

Hot extraction
according to Randall



ES 6

Extraction

Assembly of separate components

for Soxhlet extractions

behr apparatur
KEX 30/KEX 30F
KEX 60/KEX 60F
KEX 100/KEX 100-FB/KEX 100 F/KEX 100 F-FB
KEX 150/KEX 150-FB/KEX 150 F/KEX 150 F-FB
KEX 250/KEX 250-FB/KEX 250 F/KEX 250 F-FB
KEX 500 TK/KEX 500 F-TK
KEX 1.000 F-TK
KEX 2.000 F-TK
KEX 5.000 TK

Extraction
30 ml
60 ml
100 ml
150 ml
250 ml
500 ml
1.000 ml
2.000 ml
5.000 ml

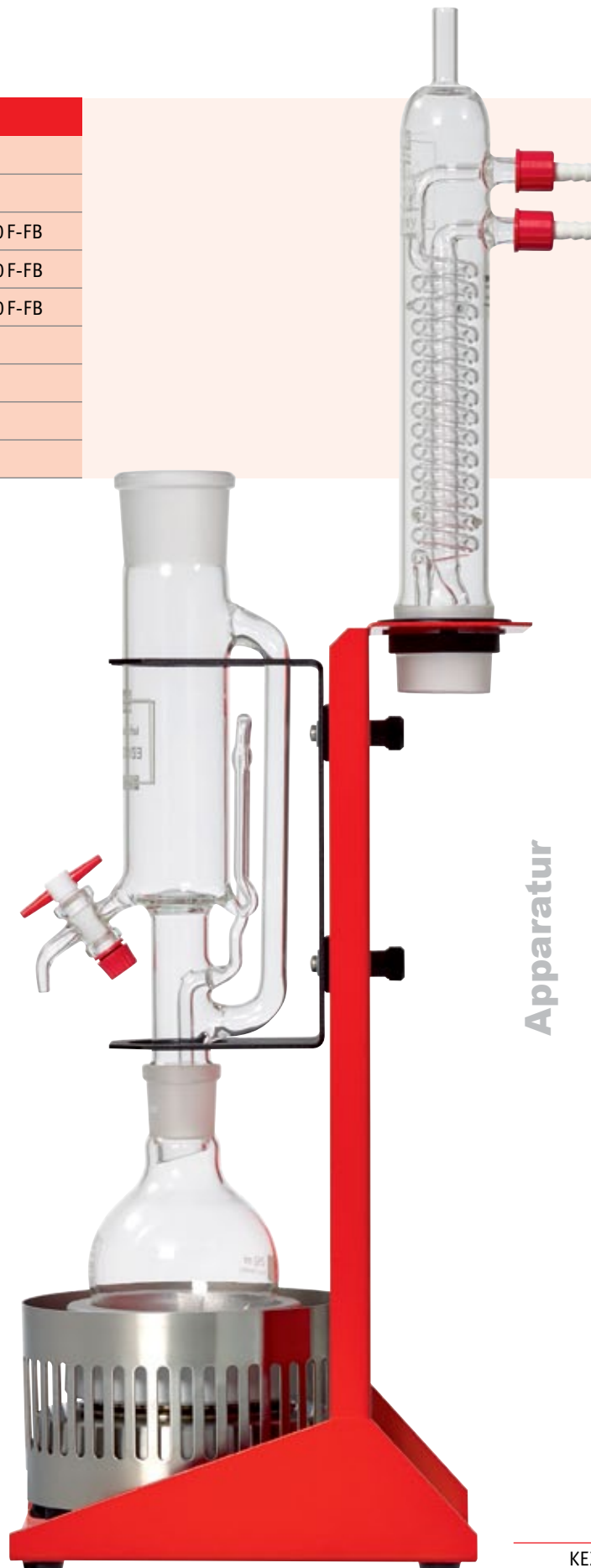

Apparatur

KEX 100 F

Round-bottomed flask	Flat-bottomed flask	Extractor	Extraction thimbles	Glass condenser	Titanium condenser
100 ml	-	30 ml	EX 30 HS	RFK 30	-
250 ml	-	60 ml	EX 60 HS	RFK 60	-
250 ml	250 ml	100 ml	EX 100 HS	RFK 100	TK 45
500 ml	500 ml	150 ml	EX 150 HS	RFK 100	TK 45
500 ml	500 ml	250 ml	EX 250 HS	RFK 100	TK 45
1.000 ml	-	500 ml	EX 500 HS	-	TK 60
2.000 ml	-	1.000 ml	EX 1000 HS	-	TK 71
5.000 ml	-	2.000 ml	-	-	TK 60
10.000 ml	-	5.000 ml	-	-	TK 60

Round-bottomed flask

or

Flat-bottomed flask

Extractor

Extraction thimbles

Glass condenser

or

Titanium condenser



RK 250



FB 70/250



EZ 100



EX 100 HS



RFK 100



TK 45

Soxhlet extraction

Classic fat determination



Complete single extraction units

The standard extraction method is the Soxhlet method. behr apparatus for Soxhlet extractions fulfil all the various requirements in everyday laboratory practice.

- Practical brackets for condensers and intermediate extraction pieces for safe storage between extractions
- Extractor sizes from 30 ml to 5000 ml
- Extractors with specially developed siphon tubes (make: „Bröckerhoff“) guarantee consistent extraction cycles across all sample positions
- Extractors with taps remove the need for additional distillation after the extraction
- Condensers with threaded fittings

Complete single extraction units

Complete single extraction units with base frame, heating device, bracket, tubes and glass apparatus (reaction flask, extractor, Dimroth condenser for extraction). Infinitely variable heating control. After the extraction cycle, the extractors with tap conduct the solvent directly into the dispensing bottle.

Includes extraction thimble and boiling chips in a sample pack.

Technical data the Soxhlet extraction

	KEX 30	KEX 100	KEX 250	KEX 500/1000
Voltage/Frequency	230 VAC/ 50/60 Hz			
Power consumption	450 W		1100 W	
Weight	approx. 7,5 kg			approx. 8,5 kg
Dimensions in cm (W x D x H)	approx. 23 x 33 x 71,5	approx. 23 x 33 x 80		approx. 23 x 35 x 95

KEX 2000 F und KEX 5000 F Technical data on request!

Complete single extraction units with glass condenser

Type	Item description	Item no.
KEX 30	for 30 ml extraction	B00217706
KEX 60	for 60 ml extraction	B00441131
KEX 100	for 100 ml extraction	B00217708
KEX 150	for 150 ml extraction	B00727097
KEX 250	for 250 ml extraction	B00217737
KEX 30 F	for 30 ml extraction with tap	B00217738
KEX 60 F	for 60 ml extraction with tap	B00441132
KEX 100 F	for 100 ml extraction with tap	B00217710
KEX 150 F	for 150 ml extraction with tap	B00726789
KEX 250 F	for 250 ml extraction with tap	B00217732



KEX 30



KEX 250 F



KEX 100 F-FB

Complete single extraction units – broad surface flat-bottomed flask

Type	Item description	Item no.
KEX 100-FB	for 100 ml extraction and 250 ml flat-bottomed flask	B00722656
KEX 150-FB	for 150 ml extraction and 500 ml flat-bottomed flask	B00722660
KEX 250-FB	for 250 ml extraction and 500 ml flat-bottomed flask	B00722661
KEX 100 F-FB	for 100 ml extraction with tap and 250 ml flat-bottomed flask	B00722639
KEX 150 F-FB	for 150 ml extraction with tap and 500 ml flat-bottomed flask	B00722641
KEX 250 F-FB	for 250 ml extraction with tap and 500 ml flat-bottomed flask	B00722642

Complete single extraction units – broad surface flat-bottomed flask and titanium condenser

Type	Item description	Item no.
KEX 100-FB/TK	for 100 ml extraction, 250 ml flat-bottomed flask and titanium condenser	B00722662
KEX 150-FB/TK	for 150 ml extraction, 500 ml flat-bottomed flask and titanium condenser	B00722663
KEX 250-FB/TK	for 250 ml extraction, 500 ml flat-bottomed flask and titanium condenser	B00722664
KEX 100 F-FB/TK	for 100 ml extraction with tap, 250 ml flat-bottomed flask and titanium condenser	B00722644
KEX 150 F-FB/TK	for 150 ml extraction with tap, 500 ml flat-bottomed flask and titanium condenser	B00722645
KEX 250 F-FB/TK	for 250 ml extraction with tap, 500 ml flat-bottomed flask and titanium condenser	B00722646

Complete single extraction units with integrated magnetic stirrer and titanium condenser

The heating mantle is continuously variable and has an integrated magnetic stirrer to ensure a better heat distribution of solvent and to avoid boiling retardation.

- Practical holders for the titanium condenser (page 20) and extractor (middle piece) for deposition between extractions
- Extractor sizes of 500 ml up to 5000 ml

Complete single extraction units – with round-bottomed flask and titanium condenser

Type	Item description	Item no.
KEX 500-TK	for 500 ml extraction, 1000 ml round-bottomed flask and titanium condenser	B00722666
KEX 500 F/TK	for 500 ml extraction with tap, 1000 ml round-bottomed flask and titanium condenser	B00722647
KEX 1000 F/TK	for 1000 ml extraction with tap, 2000 ml round-bottomed flask and titanium condenser	B00722651
KEX 2000 F/TK	for 2000 ml extraction with tap, 5000 ml round-bottomed flask and titanium condenser	B00722652
KEX 5000-TK	for 5000 ml extraction with tap, 10.000 ml round-bottomed flask and titanium condenser	B00696159



KEX 2000 F/TK

behrotest® series extraction devices

precisely aligned to your needs

- Practical condenser ledge to safely deposit the condenser between extractions
- Cooling water distribution strip ensures uniform cooling at sample positions
- Condensers with threaded fittings or titanium condenser
- Drip tray
- Extractors with specially developed siphon tubes guarantee consistent extraction cycles across all sample positions
- S models: Extractors with taps remove the need for additional distillation after the extraction
- PTFE tap no fixing, does not have to be greased
- Extractor sizes from 30 ml to 250 ml
- Series extraction devices with 4, 6 or 8 sample positions
- Every sample position can be individually adjusted
- Brackets for safely holding the intermediate extraction pieces after removing the sample container

behrotest® series extraction devices



behrotest® series extraction devices

behrotest® series extraction devices are the cost-effective and user-friendly solution for classic Soxhlet and fat extractions:

- Complete with reaction vessels, intermediate extraction pieces and condensers
- Energy individually adjustable for every sample position
- Cooling water distribution strip ensures uniform cooling at sample positions
- Extractors with specially developed siphon tubes (make: "Bröckerhoff") guarantee consistent extraction cycles across all sample positions
- Practical condenser ledge to safely deposit the condenser between extractions
- Brackets for safely holding the intermediate extraction pieces after removing the sample container
- S models: Extractors with taps remove the need for additional distillation after the extraction



R 304 S

Series extraction devices - round-bottom flasks

Type	Sample positions	Round-bottom flasks ml	Tap	Extractor content ml	Item no.
R 304	4	100	-	30	B00218433
R 306	6	100	-	30	B00218434
R 308	8	100	-	30	B00602363
R 304 S	4	100	+	30	B00218443
R 306 S	6	100	+	30	B00218444
R 308 S	8	100	+	30	B00602364
R 604	4	250	-	60	B00218453
R 606	6	250	-	60	B00218454
R 604 S	4	250	+	60	B00218455
R 606 S	6	250	+	60	B00218456
R 104 S	4	250	+	100	B00218425
R 106 S	6	250	+	100	B00218424
R 108 S	8	250	+	100	B00441134
R 254 S	4	500	+	250	B00218435
R 256 S	6	500	+	250	B00218436



R 108 S



Series extraction devices – broad surface flat-bottomed flask

Type	Sample positions	Flat-bottomed flask ml	Tap	Extractor content ml	Item no.
R 104 S-FB	4	250	+	100	B00705758
R 106 S-FB	6	250	+	100	B00705278
R 108 S-FB	8	250	+	100	B00713792
R 254 S-FB	4	500	+	250	B00723562
R 256 S-FB	6	500	+	250	B00723563
R 258 S-FB	8	500	+	250	B00723564



R 108 S-FB

Series extraction devices – broad surface flat-bottomed flask and titanium condenser

Type	Sample positions	Flat-bottomed flask ml	Tap	Extractor content ml	Item no.
R 104 S-FB/TK	4	250	+	100	B00726459
R 106 S-FB/TK	6	250	+	100	B00705289
R 108 S-FB/TK	8	250	+	100	B00726460
R 254 S-FB/TK	4	500	+	250	B00726461
R 256 S-FB/TK	6	500	+	250	B00726464
R 258 S-FB/TK	8	500	+	250	B00726465

Technical data for the series extraction devices

	4 Sample positions	6 Sample positions	8 Sample positions
Voltage	230 VAC		
Frequency	50/60 Hz		
Power consumption	1500 W	2200 W	2900 W
Power consumption	7 A	10 A	13 A
Weight (without glass)	approx. 15 kg	approx. 20 kg	approx. 25 kg
Dimensions in cm (W x D x H) (without glass)	approx. 53 x 32 x 74	approx. 76 x 32 x 74	approx. 90 x 32 x 74



R 106 S-FB/TK



WABEX 110



WABEX 210



WABEX 425

Series extraction devices - with water bath for highly flammable solvents

The behrotest® waterbath extraction units are suitable for ideal and gentle extractions when using highly inflammable solvents.

- Maximum temperature of heat transfer medium up to 100°C
- On breakage of the vessel, the solvent flows in to the water

Series extraction devices - with water bath, includes glassware and connection tubes

Type	Item description	Extractor content ml	Item no.
WABEX 110	1 sample position	100	B00725955
WABEX 125	1 sample position	250	B00725962
WABEX 210	2 sample positions simultaneously	100	B00726455
WABEX 225	2 sample positions simultaneously	250	B00726458
WABEX 410	4 sample positions simultaneously	100	B00513701
WABEX 425	4 sample positions simultaneously	250	B00513702
WABEX 610	6 sample positions simultaneously	100	B00513703
WABEX 625	6 sample positions simultaneously	250	B00513704

Technical data

	WABEX 110/125	WABEX 210/225
Dimensions in cm (H x W x D)	70 x 41 x 40	70 x 41 x 40
Weight (without glass)	9 kg	10 kg
Nominal voltage	230 V	230 V
Power consumption	1500 W	1500 W

	WABEX 410/425	WABEX 610/625
Dimensions in cm (H x W x D)	81 x 68 x 32	81 x 98 x 32
Weight (without glass)	15 kg	19 kg
Nominal voltage	230 V	230 V
Power consumption	1000 W	1500 W

Benefits

of the new broad surface flat-bottomed flask from behr

behrotest® Flat-bottomed with broad surface: Safe and practical

behr precision aluminum adapters are required for classical use of round-bottom flasks. When using the new behrotest® flat-bottom flasks these are not required.

For conventional round-bottomed flasks the user needs additional cork rings to position the flask on the working surface.

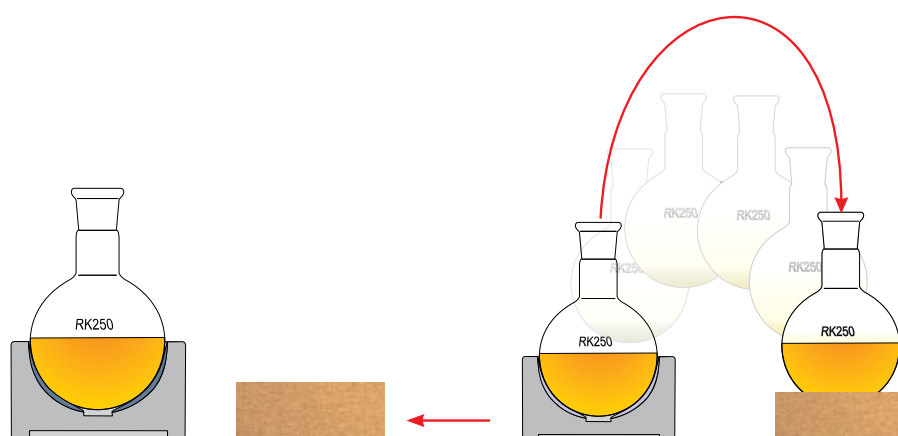

RK 250

Why not use a flat-bottomed flask which really stands firmly?

Working with behrotest® flat-bottomed flasks, enables the user to position the glassware on any level surface.

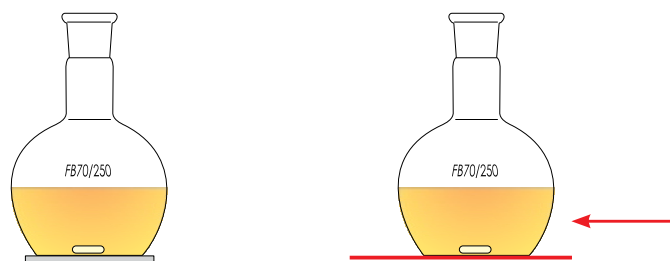

FB 70/250

- Stands safely, no wobbling, does not tilt
- Magnetic stirring rods rotate evenly
- 4 x times higher contact surface, enabling quicker heating while saving energie
- Version with ground glass joint for insertion in complex apparatuses

Accessories for the Soxhlet extraction



RK 250



FB 70/250



AM 100/SET



EZ 100 H

Round-bottomed flask

Type	Item description	Item no.
RK 100	100 ml, for 30 ml extraction, (NS29/32)	B00218501
RK 250	250 ml, for 60 ml and 100 ml extraction, (NS 29/32)	B00218499
RK 500	500 ml, for 250 ml extraction, (NS 29/32)	B00218500
RK 1000	1000 ml, for 500 ml extraction, (NS 29/32)	B00218502
RK 2000	2000 ml, for 1000 ml extraction, (NS 29/32)	B00652062
RK 5000	5000 ml, for 2000 ml extraction, (NS 29/32)	B00703312
RK 10000	10000 ml, for 5000 ml extraction, (NS 29/32)	B00703313

Broad surface flat-bottomed flask

Type	Item description	Item no.
FB 70/250	250 ml, for 100 ml extraction	B00693984
FB 70/500	500 ml, for 150 ml and 250 ml extraction	B00713799

Positioning cradles

Type	Item description	Item no.
AM 100/SET	for 100 ml round-bottomed flask incl. distance inlay	B00217701
AM 250/SET	for 250 ml round-bottomed flask incl. distance inlay	B00694928
AM 500/SET	for 500 ml round-bottomed flask incl. distance inlay	B00713234

Extractors

Type	Item description	Item no.
EZ 30	Soxhlet extractor, 30 ml	B00217966
EZ 30 H	Soxhlet extractor, 30 ml, with Tap	B00217977
EZ 60	Soxhlet extractor, 60 ml	B00592289
EZ 60 H	Soxhlet extractor, 60 ml, with Tap	B00592290
EZ 100	Soxhlet extractor, 100 ml	B00217967
EZ 100 H	Soxhlet extractor, 100 ml, with Tap	B00217970
EZ 150	Soxhlet extractor, 150 ml	B00705755
EZ 150 H	Soxhlet extractor, 150 ml, with Tap	B00705756
EZ 250	Soxhlet extractor, 250 ml	B00217974
EZ 250 H	Soxhlet extractor, 250 ml, with Tap	B00217973
EZ 500	Soxhlet extractor, 500 ml	B00217980
EZ 500 H	Soxhlet extractor, 500 ml, with Tap	B00217981
EZ 1000 H	Soxhlet extractor, 1000 ml, with Tap	B00373164
EZ 2000 H	Soxhlet extractor, 2000 ml, with Tap	B00688801
EZ 5000	Soxhlet extractor, 5000 ml	B00703314

Extraction thimbles

Type	Item description	Item no.
EX 30 HS	for EZ 30 (EZ 30H), package includes 25 units	B00600440
EX 60 HS	for EZ 60 (EZ 60H), package includes 25 units	B00604374
EX 100 HS	for EZ 100 (EZ 100H), package includes 25 units	B00600442
EX 150 HS	for EZ 150 (EZ 150H), package includes 25 units	B00713795
EX 250 HS	for EZ 250 (EZ 250H), package includes 25 units	B00217975
EX 500 HS	for EZ 500 (EZ 500H), package includes 25 units	B00600462
EX 1000 HS	for EZ 1000H, package includes 25 units	B00602316



EX 100 HS

Extraction thimbles glassware

Type	Item description	Item no.
EX 2000 HSG	for EZ 2000 H, glassware	B00688800
EX 5000 HSG	for EZ 5000, glassware	B00704619

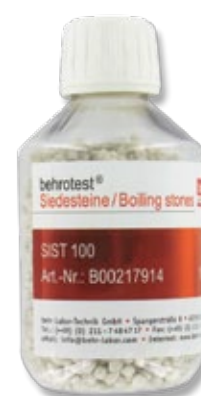

SIST 100

Boiling stones

Type	Item description	Item no.
SIST 100	behrotest® boiling stones, capacity 100 g	B00217914

Stands

Type	Item description	Item no.
RIP 4	for 4 extraction thimbles up to \varnothing 38 mm	B00602349
RIP 6	for 6 extraction thimbles up to \varnothing 38 mm	B00602350



RIP 4 und RIP 6

Desiccator/ Silica gel

Type	Item description	Item no.
EXK 300	behrotest® Desiccator, borosilicate glass 3.3, with plastic knob and porcelain plate (DN 300)	B00711550
SG 500	behrotest® Silica gel with self-indicating (orange gel), 1-3 mm, 500 g	B00726297
SG 1000	behrotest® Silica gel with self-indicating (orange gel), 1-3 mm, 1000 g	B00726298



EXK 300



SG 1000



RFK 100

behr extraction condenser RFK

behr extraction condensers RFK ensure minimal loss of solvent also at higher room or cooling water temperatures.

- More coils
- Optimized gradient cooling coil
- Maximal cooling surface
- Cooling attachments with threaded screw

behr glass condenser

Type	Item description	Item no.
RFK 30	for 30 ml extractors	B00217955
RFK 60	for 60 ml extractors	B00592291
RFK 100	for 100 ml und 250 ml extractors	B00218214



TK 45

behr extraction condenser TK

behr titanium condensers provide a high cooling capacity at higher room or cooling water temperatures.

- 20 times higher heat dissipation than glass
- Durable material (titanium)
- Retrievable cooling coil for easy cleaning
- PTFE connector with quick lock

behr titanium condenser

Type	Item description	Item no.
TK 45	for 100 ml und 250 ml extractors	B00705276
TK 60	for 500 ml extractors	B00705277
TK 71	for 1000 ml extractors	B00705883

Use of the behrotest® PTFE sleeve



PTFE sleeves

Type	Item description	Item no.
PTFE 29	PTFE sleeves for 30 ml extractors	B00217905
PTFE 34	PTFE sleeves for 60 ml extractors	B00602392
PTFE 45	PTFE sleeves for 100 ml and 250 ml extractors	B00217909
PTFE 60	PTFE sleeves for 500 ml extractors	B00602391
PTFE 71	PTFE sleeves for 1000 ml extractors	B00602374

Use of the behrotest® DOS

behrotest® dispenser for metering acid and solvent



Type	Item description	Item no.
DOS 25	behrotest® dispenser for metering acid and solvent, 2.5-25 ml adjustable without bottle	B00661157
DOS 50	behrotest® dispenser for metering acid and solvent, 5-50 ml adjustable without bottle	B00217810
LGF 2000	Laboratory with ISO-Thread, 2000 ml with pitch, crystal clear with ring stopper, without cap	B00225419

Hot extraction

according to Twisselmann

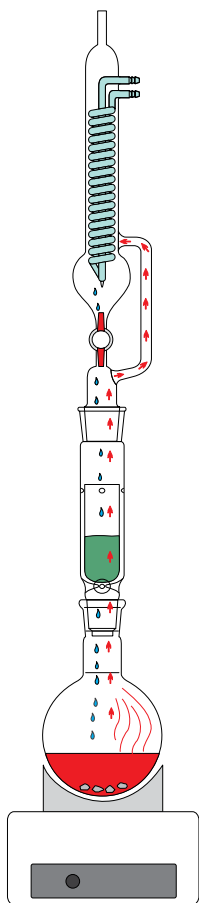

The extraction according to Twisselmann is a continuous hot extraction. It functions in a similar manner to the Soxhlet extraction. However, the temperature in the sample in the Twisselmann extractor is extremely hot, i.e. close to the solvent's boiling point. This improves solubility and shortens the extraction time.

The higher extraction temperature results from the condensed solvent flowing through the extraction thimble from above mixing with the rising, hot solvent vapour from below. The temperature of the mixture is much higher than that of the condensed solvent.

The Twisselmann extraction reduces the extraction time by up to 50% compared to the Soxhlet extraction.

Single extraction unit for hot extraction according to Twisselmann

Complete single extraction unit with base frame, heating device, bracket, tubes and glass apparatus (reaction flask, extractor, Dimroth condenser for extraction) as well as a sample pack with extraction thimbles and boiling chips.

Type	Item description	Item no.
KEX 30 T	Single extraction unit for 30 ml hot extraction according to Twisselmann	B00722667
KEX 100 T	Single extraction unit for 100 ml hot extraction according to Twisselmann	B00217734



KEX 100 T

behrotest® series extraction devices for hot extraction according to Twisselmann

Cost-effective and user-friendly apparatus for hot extraction according to Twisselmann

- Energy individually adjustable for every sample position
- Cooling water distribution strip ensures uniform cooling at sample positions
- Practical condenser ledge to safely deposit the condenser between hot extractions
- Brackets for safely holding the intermediate extraction pieces after removing the sample container

behrotest® series extraction devices for hot extraction according to Twisselmann - round-bottomed flasks

Type	Item description	Item no.
R 306 T	Complete for 6 positions simultaneously with 100 ml round-bottomed flasks	B00722668
R 104 T	Complete for 4 positions simultaneously with 250 ml round-bottomed flasks	B00218447
R 106 T	Complete for 6 positions simultaneously with 250 ml round-bottomed flasks	B00218445



R 106 T

behrotest® series extraction devices for hot extraction according to Twisselmann - broad surface flat-bottomed flask

Type	Item description	Art.-Nr.
R 104 T-FB	Complete for 4 positions simultaneously – broad surface flat-bottomed flask 250 ml	B00707366
R 106 T-FB	Complete for 6 positions simultaneously– broad surface flat-bottomed 250 ml	B00707715
R 108 T-FB	Complete for 8 positions simultaneously– broad surface flat-bottomed 250 ml	B00707715

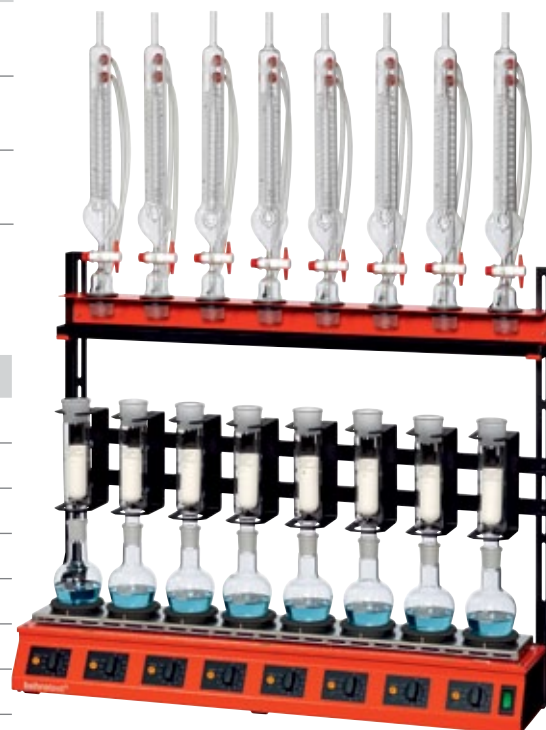

R 108 T-FB

Accessories for extractions

Type	Item description	Item no.
EZT 30	Extractor, 30 ml, for the Twisselmann extractors	B00521000
EZT	Extractor, 100 ml, for the Twisselmann extractors	B00217978
EX 30 HS	Extraction thimbles for EZT 30, package includes 25 units	B00600440
EX 100 HS	Extraction thimbles for EZT, package includes 25 units	B00600442
PTFE 29	PTFE sleeves for 30 ml extractors, package includes 12 units	B00217905
PTFE 45	PTFE sleeves for 100 ml extractors	B00217909
RK 100	Round-bottomed flask, 100 ml, for 30 ml extraction	B00218501
RK 250	Round-bottomed flask, 250 ml, for 100 ml extraction	B00218499
FB 70/250	Broad surface flat-bottomed, 250 ml, for 100 ml extraction	B00693984
RFKT 30	Condenser for 30 ml Twisselmann extractors	B00688032
RFKT	Condenser for 100 ml Twisselmann extractors	B00217979

Hot extraction according to Randall

for faster extraction



Only necessary on high fat content and bound fat

Hydrolysis principle

This acid digestion process dissolves both "free fats" as well as "bound fats" from the overall fat content.

The fat is frequently naturally enclosed in the cell matrix of the food or fodder or chemically bound. In these cases, a hydrolysis step before extraction completely releases the fat. Determination of total fat content according to Weibull and Stoldt.

The user filters the hydrolysate of the separated sample by using a glass sample tube filled with sand or Celite.

The user then rinses the fatty filter residue with water in order to remove the acid.



HY 6

Sample preparation

After drying, the filter residue is finally extracted.
This is done by applying one of the following method:
Hot extraction according to Randall



ES 6

Extraction

behrotest® semi-automatic equipment

for hot extraction according to Randall

The semi-automatic extraction systems ES 2+2 / ES 6 save time and costs by a fast extraction.

The hot extraction system following Randall is several times faster than the conventional Soxhlet extraction.



ES 6



TGE 6



TGE 4

Multi-position extraction units:

- Step-by-step user-friendly instructions on the display
- One heating program for all sample positions, but separate heating for each sample position
- Cooling water manifold ensures uniform cooling at all sample locations
- Low solvent losses due to the specially designed behrotest® coolers
- 31 freely configurable programs for your individual extraction applications
- behr one-button operation for particularly fast and easy programming
- Audible and visual error messages
- Integrated overtemperature protection
- Resource-saving cooling water saving program

Semi-automatic hot extraction apparatus according to Randall

Type	Item description	Item no.
ES 2+2	for 4 sample places with 100 ml extraction tubes	B00704623
ES 6	for 6 sample places with 100 ml extraction tubes	B00704624

Technical data

	ES 2+2	ES 6
Number of sample positions	4	6
Dimensions (W x D x H)	56 x 52 x 67 cm	72 x 52 x 67 cm
Weight	42 kg	50 kg
Nominal voltage	230 V~, 50/60 Hz	
Nominal power	1000 W	1500 W
Display	LCD	
Solution volume	60 ml; max 75 ml	
Solvent recovery	Up to 90 %	
Reproducibility	± 1%	
Temperature range	From 20 to 260 °C	
Time setting range	1 – 999 min, digitally adjustable	
Programs	31	
Water consumption	2 l/min	

Good to know:

For particularly high fat contents and bound fats we recommend the compatible HY6 hydrolysis unit for total fat determination

Accessories

Type	Item description	VPE	Item no.
FF 30	behrotest® beaker for extraction		B00687525
MCR	Clamping ring, magnetic		B00707723
EX 75 HS	Extraction sleeve suitable for FF30	Pack of 25	B00600441
SIST 100	behrotest® boiling stones	100 g	B00217914
TGE 4	Heat shield/support frame for 4 extraction beakers		B00734885
TGE 6	Heat shield / support frame for 6 extraction beakers		B00734886
DEH	behrotest® PTFE lid, white		B00707719
VSL	Viton sealing ring		B00734892
BSL	Butyl sealing ring		B00734878
PSL	PTFE sealing ring		B00734879
HST 6	Stand for 6 extraction sleeves		B00734880
ESG 6	Desiccator stand for 6 extraction cups		B00734881
WAN	PTFE weighing rack		B00734884
EXK 300	behrotest® Desiccator, borosilicate glass 3.3, with plastic knob and porcelain plate (DN 300)		B00711550
SG 500	behrotest® Silica gel with self-indicating (orange gel), 1-3 mm	500 g	B00726297
SG 1000	behrotest® Silica gel with self-indicating (orange gel), 1-3 mm	1000 g	B00726298
	Hot Hand		B00120655



EXK 300



ESG 6



SG 1000

WAN plus MCR
and EX75 HS

EX 100 HS



HST 6

Hydrolysis

Sample preparation for the extraction

The Weibull-Stoldt method

The quantitative determination of the fat content of food is performed by extraction with a solvent. The "free fat" is determined by direct extraction. The "total fat content" includes both the "free fat" and the "bound fats" that are dissolved by acid digestion (hydrolysis).

State-of-the-art equipment

behrotest® hydrolysis unit for acid digestion

HY 6 is an apparatus equipped with manual energy control for 6 sample positions with highly uniform and rapid heating provided by the built-in high-quality quartz infrared emitters. Full heating power is reached within 1 minute, which eliminates the need for preheating.

With the behrotest® **quick-engagement system**, the individual sample vessels can be quickly and easily inserted into the IR heating system and brought out. Each sample vessel can then be filtered off and flushed in parallel or individually.

The HY 6 hydrolysis-filtration unit as basic unit consists of:

- Quick digestion system with manual energy control and direct heating of the samples
- Round bottom digestion vessel 250 ml
- Glass crucible, porosity 1
- Suction tubes
- Suction bridge with PTFE plug and one suction connection with threaded fitting
- Celite 545, 1 kg
- Quartz sand, 2 kg

Optional: For continuous vacuum during acid hydrolysis and subsequent filtration please use our optional behrotest® suction units.

behrotest® hydrolysis unit HY6

Type	Item description	Item no.
HY 6	for 6 sample places	B00734467

Technical data HY 6

Number of sample positions	6
Dimensions (W x D x H)	54 x 37 x 63 cm
Weight	20 kg
Nominal voltage	230 V~, 50/60 Hz
Nominal power	1500 W
Energy adjustment range	0 - 100 %



HY 6

Accessories

Type	Item description	VPE	Item no.
AST 6	Stand for round-bottom digestion vessels SR3i		B00734893
TST 6	Stand for glass crucibles		B00734894
HYR	Tube holder for the glass crucibles		B00707740
GT	Glass crucible		B00734888
SR3i	Round bottom digestion vessel		B00217959
ASR	Suction tubes		B00734889
ASB 6	Suction bridge with PTFE plug and one suction connection with threaded fitting		B00734890
CEL	Celite 545	1 kg	B00734882
QSH	Quartz sand	2 kg	B00734883



SR 3i



AST 6



TST 6



EXR 4

Classical apparatus

behrotest® hydrolysis unit for acid digestion

Hydrolysis-digestion apparatus with 4 or 6 sample positions.

Complete with:

- 600 ml beaker
- Water-cooled condenser with cool water distribution
- Condenser stand with drip tray
- Heating positions individually infinitely adjustable
- Main power switch with pilot light

Fully assembled complete device with all the necessary accessories.

behrotest® hydrolysis unit for acid digestion

Type	Item description	Item no.
EXR 4	Hydrolysis unit, 4 sample positions	B00218446
EXR 6	Hydrolysis unit, 6 sample positions	B00218448



FU 4

behrotest® filtration unit made of borosilicate glass

Complete with:

- Filtration attachment, 400 ml, threaded
- PP funnel, threaded
- Sieve plate with 2 seals
- Stainless steel frame

Filtration unit for hydrolysis

Type	Item description	Item no.
FU 4	Filtration unit for hydrolysis with 4 positions	B00441135
FU 6	Filtration unit for hydrolysis with 6 positions	B00441144



SIMVAC

Suited for attachment to a water jetstream pump/ vacuum pump:

Type	Item description	Item no.
SIMVAC	behrotest® suction unit with water jet pump, collection bottle 2 l and tubes	B00217922
AFP 2	behrotest® suction unit with diaphragm vacuum pump, collection bottle 2 L and tubes	B00734891



The behr range for Distillation



Determination of the alcohol and volatile acid content



D 1



D 2



behrotest®
maintenance set

Steam distillation units D 1 and D 2

- Alcohol
- Organic acids SOS
- Beer fermentation process
- Ammonium chloride in liquorice products

Apparatus for determining the alcohol content and the volatile acids in wine and other alcoholic drinks. Complete glassware set with volumetric flask and pycnometer. behr D 1 and D 2 are particularly well suited for high sample throughputs due to their speed.

Type	Item description	Item no.
D 1	behrotest® steam distilling apparatus for determining the alcohol content, distillation in a pycnometer	B00218039
D 2	behrotest® steam distilling apparatus for determining organic acids, distillation in a 500 ml Erlenmeyer flask	B00218040
D 1-AM	behrotest® steam distilling apparatus for determining alcohol using Areometer, distillation in reaction vessel 750 ml	B00712946

Accessories

Type	Item description	Item no.
D 1-AM-Set	behrotest® accessories set for D1-AM consisting of: Areometer and areometer cylinder 500 ml	B00723220
D1 & D2-Set	behrotest® maintenance set	B00606938

Technical data for behr D 1, D 2 and D 1-AM

Dimensions in cm (W x H x D)	approx. 41 x 67,5 x 41	
Weight	approx. 32 kg	
Nominal voltage	230 VAC	50 Hz/ 60 Hz
Power consumption	1700 W	9 A /18 A
Cooling water consumption	approx. 5 l/min	
Storage container	any size, recommendation: behrotest® canister set	
Display	LCD	
Programs	1	

Determination of the essential oil content

Systems for determining the essential oil content

Complete compact system for determining the essential oil content in

- Pharmaceuticals,
- Spices
- Seasoning and
- Herbs

according to ISO 6571.

With base frame, heating devices, brackets, coolant hoses and glass apparatus.

Systems for determining the essential oil content

Type	Item description	Item no.
KOL	1 sample position with 500 ml flask	B00217736
KOL 2	1 sample position with an integrated magnetic stirrer in a 1000 ml flask	B00602393
KOL 6	6 sample positions with with integrated magnetic stirrer, 6 sample positions with 1000 ml flasks	B00705271

Complete compact system for determining the essential oil content in citrus fruits and their derivatives according to Clevenger (ISO 1955).

Type	Item description	Item no.
CLE-RK1	Compact system for determining the essential oils in citrus fruits and their derivatives, round bottom flask 1000 ml	B00696819
CLE	Compact system for determining the essential oils in citrus fruits and their derivatives, Erlenmeyer flask 3000 ml	B00217741



KOL



CLE

Water content

System for determining the water content by azeotropic distillation

Complete compact system for determining the water content by azeotropic distillation. Suitable for inhomogeneous, bulky food such as dried fruit, sauerkraut, etc. With base frame, heating device, bracket and glass apparatus.

Type	Item description	Item no.
KWA 500	1 sample position, behrotest® compact apparatus	B00217690
KWA 500/4	4 sample positions, behrotest® series water distiller	B00632492
KWA 500/6	6 sample positions, behrotest® series water distiller	B00632493



KWA 500

Reflux distillation



KRD 100

Single reflux distillation apparatus

Complete apparatus for reflux distillation, consisting of

- Complete frame with condenser support panel and condenser bracket
- Positioning cradle
- Reaction flask
- behr high-performance glass cooler
- Tubing

Single reflux distillation apparatus

Type	Item description	Item no.
KRD 50	1 heating position for 50 ml round-bottomed flasks, complete	B00602400
KRD 100	1 heating position for 100 ml round-bottomed flasks, complete	B00602401
KRD 250	1 heating position for 250 ml round-bottomed flasks, complete	B00602402
KRD 500	1 heating position for 500 ml round-bottomed flasks, complete	B00602403
KRD 1000	1 heating position for 1,000 ml round-bottomed flasks, complete with magnetic stirrer	B00602404



RH 254

Reflux distillation apparatus

Complete apparatus for reflux distillation, consisting of

- Hot bar, 4 heating positions
- Positioning cradles
- Support rods
- Cooling water distribution with condenser support panel and condenser brackets
- Reaction flask
- behr high-performance glass coolers

Series reflux distillation apparatus

Type	Item description	Item no.
RH 104	4 heating positions for 100 ml round-bottomed flasks, complete	B00602394
RH 106	6 heating positions for 100 ml round-bottomed flasks, complete	B00602397
RH 254	4 heating positions for 250 ml round-bottomed flasks, complete	B00602395
RH 256	6 heating positions for 250 ml round-bottomed flasks, complete	B00602398
RH 504	4 heating positions for 500 ml round-bottomed flasks, complete	B00602396
RH 506	6 heating positions for 500 ml round-bottomed flasks, complete	B00602399



RH 256 M

Series reflux distillation apparatus with magnetic stirrer

Type	Item description	Item no.
RH 256 M	6 heating positions for 250 ml flat bottom reaction vessel, complete, block with integrated magnetic stirrer	B00696821
RH 506 M	6 heating positions for 500 ml flat bottom reaction vessel, complete, block with integrated magnetic stirrer	B00726590
RH 1006 M	6 heating positions for 1000 ml flat bottom reaction vessel, complete, block with integrated magnetic stirrer	B00726591

Technical data for reflux distillation apparatus

	4 sample positions	6 sample positions	6 sample positions with magnetic stirrer
Voltage	230 VAC		
Frequency	50/60 Hz		
Power consumption	1500 W	2250 W	2050 W
Power consumption	7 A	10 A	9 A
Weight (without glass)	approx. 15 kg	approx. 20 kg	approx. 48 kg
Dimensions in cm (W x D x H) (without glass)	approx. 53 x 32 x 74	approx. 76 x 32 x 74	approx. 75 x 40 x 100

Saponification value

The method for the determination of saponification value in animal and vegetable fats and oils is effected in accordance with DIN EN ISO 3657. With an excess of ethanolic potassium hydroxide solution the tested sample is saponified by boiling under reflux and later titrated with standard hydrochloric acid solution until reaching the end point.

behrotest® distillation unit for the determination of saponification value

The complete programmable distillation unit consists of:

- 6 or 12 round digestion vessels SR 2, 250 ml, with standard ground joint NS 29 and container ring made of PVDF
- compact rack with cooler frame and holders
- behr high performance glass coolers
- cooling water distribution strip ensures uniform cooling at sample positions
- 25 freely configurable programs for block temperature and distillation time
- high-quality quartz infrared heaters (1500 W)
- integrated magnetic stirrer with the separate control unit
- Tubing

Reflux distillation apparatus for the determination of saponification value

Type	Item description	Item no.
VFZ 6	behrotest® reflux distillation apparatus for the determination of saponification value, 6 positions simultaneously	B00696815
VFZ 12	behrotest® reflux distillation apparatus for the determination of saponification value, 12 positions simultaneously	B00696816

Optionally available in the behr program is the manual titration station HTI 9.

The HTI 9 consists of a burette with digital display and a magnetic stirrer with fitting holder for SR2 reaction vessels.

Type	Item description	Item no.
HTI 9	behrotest® manual titration station with digital burette, magnetic stirrer	B00707777



VFZ 12



HTI 9

Determination of Vitamin A and E



VAE 6 together with KW 6

behrotest® saponification apparatus for determination of vitamin A and E

The method for the determination of vitamin A and vitamin E in foodstuffs by high-performance liquid chromatography (HPLC) is effected in accordance with DIN EN 12823-1 and DIN EN 12822. The sample preparation takes place in the behrotest® saponification apparatus. Since the samples are sensitive to atmospheric oxygen, the samples are saponified under reflux preferably under a nitrogen atmosphere.

The complete apparatus consists of:

- Reaction vessels
- behr high performance glass coolers
- Cooling water distribution strip ensures uniform cooling at sample positions
- Precision heating block with integrated magnetic stirrers
- Separate control unit with very precise temperature control
- Flowmeter for nitrogen

Saponification apparatus

Type	Item description	Item no.
VAE 6	behrotest® saponification apparatus for the determination of vitamin A and E in the heating block with integrated magnetic stirrers, 6 positions with 250 ml vessels	B00707766

Optional: behrotest® cooling trough

Type	Item description	Item no.
KW 6	behrotest® cooling trough for smple rack EG 6/RF	B00726596

Determination of sulfite



KSO 2N

The determination of sulfite (sulfurous acid) in food is carried out in accordance with DIN EN 1185 and DIN EN 1988-1 (optimized Monier-Williams method). The apparatus is for the release and distillation of sulfurous acid.

- reaction flask 500 ml or 1000 ml
- Systems available with one or two absorption vessels.
- Heating hood with an integrated magnetic stirrer for even mixing
- 1 or 6 sample positions possible
- The injection volume flow is set with a precision flow meter

Type	Item description	Item no.
KSO 2N	Compact system for the determination of sulfurous acid in accordance with DIN EN 1185, 2 absorption vessels, magnetic stirrer.	B00604572
SO 2-6	Devices for the determination sulfurous acid in up to 6 sample positions simultaneously in accordance with DIN EN 1185. 2 absorption vessels. Magnetic stirrer.	B00218429
SU 1000	Compact system for the determination of Sulfite in accordance with DIN EN 1988-1 (Optimized Monier-Williams method)	B00652910

Determining hydroxyproline content

Classic behrotest® digestion apparatus for determining hydroxyproline content

Apparatus for digestion testing when determining hydroxyproline content in meat, meat products and sausage products according to Sec. 64 LFGB (German Feed and Food Act). After acidic digestion, hydroxyproline is photometrically determined at 558 nm.

The equipment consists of:

- Serial heating block with 6 sample positions
- Each sample position individually adjustable
- Deposit pit
- Support rods
- Cooling water distribution with condenser console and holders
- Digestion vessels with a volume of 250 ml.
- for high-performance condensers

Digestion apparatus

Type	Item description	Item no.
RH 4	behrotest® series heating block for determining hydroxyproline content with 4 sample positions, for 250 ml digestion vessels	B00218449
RH 6	behrotest® series heating block for determining hydroxyproline content with 6 sample positions, for 250 ml digestion vessels	B00218426



RH 6

Modern behrotest® digestion apparatus for determining hydroxyproline content

Apparatus for digestion testing when determining hydroxyproline content in meat, meat products and sausage products according to Sec. 64 LFGB (German Feed and Food Act). After acidic digestion, hydroxyproline is photometrically determined at 558 nm.

Modern infrared heating units from behr are equipped with high-quality quartz infrared heaters, built-in inductive magnetic stirrers and a temperature control.

- Apparatus with high-quality non-corrosive block casing made of stainless steel
- Insertable frame for 6 or 12 spaces
- Digestion vessels with a volume of 250 ml.
- Firmly sealing vessels with high temperature screw caps made of PP (GL 32) with welded PTFE membrane for pressure compensation, suitable for autoclaving
- 25 freely configurable programs for block energy and digestion time
- Even heating on all sample positions
- 6 or 12 digit integrated inductive magnetic stirrer
- behr one-button operation for extremely easy and quick programming
- Menu navigation in country language

Digestion apparatus for determining hydroxyproline content

Type	Item description	Item no.
HDP 6	behrotest® digestion apparatus for determining hydroxyproline content with 6 sample positions, for 250 ml digestion vessels	B00696810
HDP 12	behrotest® digestion apparatus for determining hydroxyproline content with 12 sample positions, for 250 ml digestion vessels	B00696811



HDP 6



HDP 12

Recirculating cooler

The UK series



UK 12/1030

behrotest® UK recirculating cooler

behrotest® UK series recirculating coolers are ideally suited for use with the behr separation and distillation systems. The new and improved successor models of our UK 12 series are just as reliable and suitable for everyday use as their predecessors, but their performance has improved by 20%.

They are also generally suited

- as replacements for condensing systems that are cooled using domestic water
- for the dissipation of process heat
- for the thermostatic control of apparatus such as centrifuges, microscopes, spectrometers, analysers, distillation apparatus, rotary evaporators, electrophoresis, reaction vessels

All recirculating coolers can be used as a closed or open system

Features:

- Electronic temperature control with LED display
- Float switch to monitor the coolant level
- Limit alarm if the permitted field of activity is exceeded
- Cooling unit: quiet, fully hermetic, air-cooled, low-maintenance
- 12 mm internally threaded tube connections (M10 x 1)
- 3/4" filler spout with vent valve on the surface of the device
- Stainless steel housing parts
- Non-ferrous metal heat exchanger
- Circumferential skirting protection rings both top and bottom
- UK 2020 has a cooling unit with two separately operating cooling circuits. This provides better setting options and the opportunity of emergency operation with the second machine if a compressor fails.

Type	Item description	Item no.
UK 12/1030	1200 watt cooling capacity with circulating pump and digital temperature control for regulating the temperature and cooling individual or several apparatus	B00692940
UK 12/2020	2200 watt cooling capacity with circulating pump and digital temperature control for regulating the temperature and cooling several apparatus	B00602389

behrotest® cooling water monitor:

The behrotest® WD 30 Coolant Monitor with emergency shut-off function is a user-friendly device for monitoring cooling circuits in the laboratory. If there is a leak in the system, it deactivates the water supply as well as the electric heating device and prevents water damage in the laboratory.

The behrotest® WD 30 is position independent, i.e. it can be operated in any position. An acoustic warning signal provides additional security.

The delivery scope of the behrotest® cooling water monitor WD 30 includes:

- Monitoring unit with two flow sensors and solenoid valve, as well as cables to connect it to the controller (1.5 m)
- Controller with Schuko-type plug to connect heating devices, etc.
- Hose set with connections
- Adapter set for connecting water lines and behrotest® recirculation coolers UK

Type	Item description	Item no.
WD 30	Monitoring unit with two flow sensors and solenoid valve, as well as cables to connect it to the controller (1.5 m)	B00645358

Technical data WD 30

Power supply	230 VAC, 50/60 Hz
Minimal through-flow quantity	5 l/min
Maximum through-flow quantity	30 l/min
Pre-pressure	0,2 to 10 bar



Use WD 30

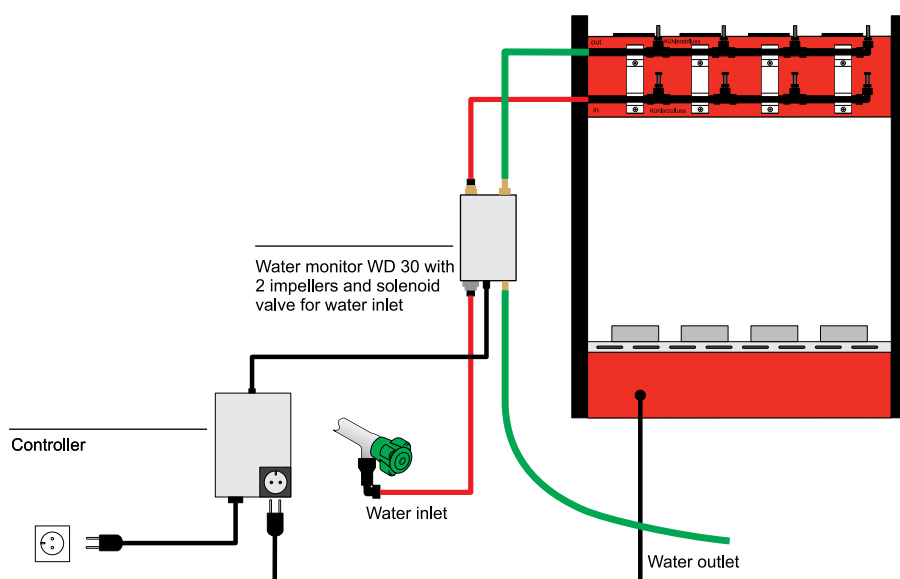

Suitable for through-flow quantities of 5 to 30 l/min. Ideal for monitoring systems with central supply of several parallel coolers (e.g. behrotest® serial extraction units, cyanide distillation unit, heavy metal digestion units, etc.).

Through the simultaneous measurement of infeed and outfeed, the behrotest® cooling water monitor WD 30 is far less susceptible to faulty triggering in the event of pressure fluctuations in water supply than conventional devices with just one flow sensor.

At the same time, the dual measurement ensures that even the most minute deviations are detected.

This may also interest you



Extraction units for extracting liquids

Determination of the nitrogen content according to Kjeldahl:

- Infrared digestion devices with manual operation and also programmable
- Block digestion unit, also with fully-automatic lift
- Steam distillation units for (almost) any requirement
- Titration devices

The complete range for the CSB titration method:

- Dosing units for sulphuric acid, manual and also programmable
- Digestion units with fully-automatic time/temperature profile for standardised CSB determination
- Titrators, manual and fully-automatic, also as dosing-titrating combination

Further determinations

- Crude fiber
- Determination of fibers
- Cyanide
- Heavy metal digestion systems



019211



behr Labor-Technik GmbH • Spangerstraße 8 • 40599 Düsseldorf/Germany
Tel.: (+49) (0) 211-7484717 • Fax: (+49) (0) 211-7484748
Email: info@behr-labor.com • Internet: www.behr-labor.com



E00603430-EN - V3_2_014